

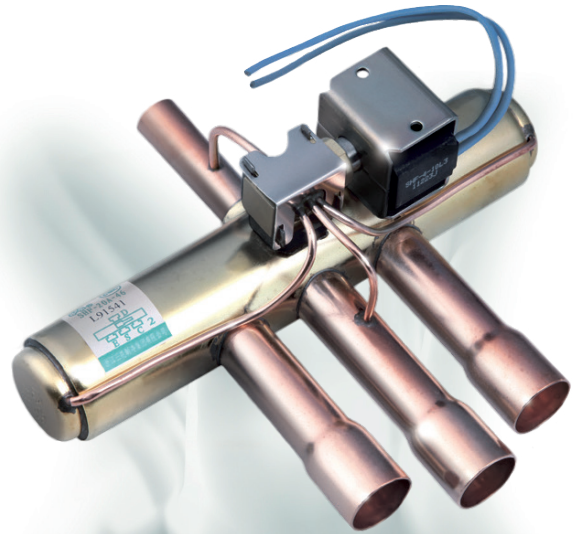

4-Wege-Umkehrventile

Die Vier-Wege-Umkehrventile der SHF Serie sind für die Anforderungen von Wärmepumpen-anlagen konzipiert worden und sorgen für die Umschaltung zwischen Kühl- und Heizmodus, indem der Strömungsweg des Kältemittels geändert wird.



EIGENSCHAFTEN

- BREITES ANWENDUNGSSPEKTRUM
- GEEIGNET FÜR KÜHLLLEISTUNGEN VON 3,6 BIS 420 KW (R410A, BEDINGUNG 2)
- IN VERSCHIEDENEN AUSFÜHRUNGEN ERHÄLTlich

ALLGEMEINE SPEZIFIKATION

- Einsetzbar für alle gängigen HFCKW und HFKW-Kältemittel wie: R22, R134a, R404A, R407C, R410A, R507A ...
- Mediumtemperatur TS min./max.: -30°C / +135°C (*)
- Umgebungstemperatur min./max.: -20°C bis +50°C
- Relative Feuchtigkeit: 0 bis 95 %
- Max. Betriebsdruck PS \geq 4,5 MPa (45 bar)
- Installation:
 - Spule nach oben oder mit Ventilachse in horizontaler Ausrichtung
 - Durchströmung entsprechend der Installationsanleitung
- Zertifizierungen: UL/CSA** und Konformitätserklärung nach LVD oder PED PED

* SHF-50-911-D2: TS min./max. : -30°C / +120°C

** SHF (L) -4H zu SHF-50 Ventile, Spulenauswahl auf Anfrage

NOMINELLE BETRIEBSBEDINGUNGEN

Nominelle Betriebsbedingungen	Betriebspunkt 1:	Betriebspunkt 2:
Verflüssigungstemperatur t_c	38°C	54,4°C
Verdampfungstemperatur t_o	5°C	7,2°C
Überhitzung Δt_{sh}	5K	5K
Unterkühlung Δt_{sc}	0K	5K

Hinweise für Leistungsdaten-Auslegungstabellen:

- 1) Druckabfall gilt für Durchströmung von $\emptyset C$ nach $\emptyset S$ oder $\emptyset E$ nach $\emptyset S$
- 2) R407C Daten basieren auf Taupunkt-Bedingungen



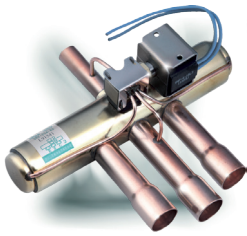

SANHUA SHF SERIE 4-Wege-Umkehrventile

ALLGEMEINE PARAMETER

Modell	Artikel-nummer	Ø Sitz [mm]	Kv [m³/h]	Anschlüsse ODF		MOP [MPa]	OPD		PED Kategorie
				ØD	ØE/S/C		Max.	Min.	
				[inch]	[inch]		[MPa]	[MPa]	
SHF(L)-3H-12U-51	10180944702	7,4	1,5	1/4	5/16	4,7	4	0,1	4,3
SHF(L)-4H-23U-51	10180944902	8	1,6	5/16	3/8	4,7	4	0,1	4,3
SHF(L)-7H-34U-51	10180945302	11,1	2,9	3/8	1/2	4,7	4	0,1	4,3
SHF(L)-7H-34-51	10180944002	11,1	2,9	3/8	1/2	4,7	4	0,1	4,3
SHF(L)-7H-35-51	10180945002	11,1	2,9	3/8	5/8	4,7	4	0,1	4,3
SHF(L)-11H-34U-51	10180947302	11,5	4,5	3/8	1/2	4,7	4	0,1	4,3
SHF(L)-11H-35U-51	10180942902	11,5	4,5	3/8	5/8	4,7	4	0,1	4,3
SHF(L)-11H-45D1-51	10180943002	11,5	4,5	1/2	5/8	4,7	4	0,1	4,3
SHF(L)-11H-46D1-51	10180944602	11,5	4,5	1/2	3/4	4,7	4	0,1	4,3
SHF-14A-46	10325030102	13,5	6,6	1/2	3/4	4,7	4	0,1	4,3
SHF-20D-46-02	10325020102	17,2	9,5	1/2	3/4	4,7	4	0,1	4,3
SHF-20D-47-02	10325030302	17,2	9,9	1/2	7/8	4,7	4	0,1	4,3
SHF-20D-57-02	10325032902	17,2	9,9	5/8	7/8	4,7	4	0,1	4,3
SHF-20D-67-02	10325039802	17,2	9,9	3/4	7/8	4,7	4	0,1	4,3
SHF-35B-47-04	10325033602	20	14,7	1/2	7/8	4,7	4	0,1	4,3
SHF-35B-57-04	10325035702	20	14,7	5/8	7/8	4,7	4	0,1	4,3
SHF-35B-59-04	10325039902	20	14,7	5/8	1 1/8	4,7	4	0,1	4,3
SHF-35B-67-04	10325031002	20	14,7	3/4	7/8	4,7	4	0,1	4,3
SHF-35B-69-04	10325035802	20,9	14,7	3/4	1 1/8	4,7	4	0,1	4,3
SHF-35B-79-04	10325033002	20,9	14,7	7/8	1 1/8	4,7	4	0,1	4,3
SHF-50A-79	10325030002	22,8	18,3	7/8	1 1/8	4,5	4	0,1	4,3
SHF-50-911D2	10325011602	25,6	18,5	1 1/8	1 3/8	4,7	4	0,1	4,3
SHF(L)-70-810	10325030201	28,6	28,5	1	1 1/4	4,5	4	0,15	4,3
SHF(L)-70-810-01	10325033101	28,6	28,5	1	1 1/4	4,5	4	0,15	4,3
SHF(L)-70-911	10325038301	28,6	28,5	1 1/8	1 3/8	4,5	4	0,15	4,3
SHF(L)-70-911-01	10325038301	28,6	28,5	1 1/8	1 3/8	4,5	4	0,15	4,3
SHF(L)-70-913-05	10325039501	28,6	28,5	1 1/8	1 5/8	4,5	4	0,15	4,3
SHF(L)-70-913-03	10325039701	28,6	28,5	1 1/8	1 5/8	4,5	4	0,15	4,3
SHF(L)-100-911	10325037901	34,8	40,5	1 1/8	1 3/8	4,5	4	0,15	I

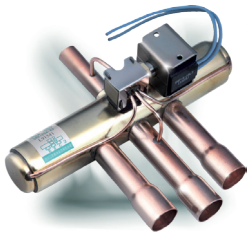

SANHUA SHF SERIE 4-Wege-Umkehrventile

ALLGEMEINE PARAMETER

Modell	Artikel-nummer	Ø Sitz [mm]	Kv [m ³ /h]	Anschlüsse ODF		MOP [MPa]	OPD		PED Kategorie
				ØD	ØE/S/C		Max.	Min.	
				[inch]	[inch]		[MPa]	[MPa]	
SHF(L)-100-911-01	10325038001	34,8	40,5	1 1/8	1 3/8	4,5	4	0,15	I
SHF(L)-100-913	10325033701	34,8	40,5	1 1/8	1 5/8	4,5	4	0,15	I
SHF(L)-100-913-01	10325034701	34,8	40,5	1 1/8	1 5/8	4,5	4	0,15	I
SHF(L)-100-1012	10325027101	34,8	40,5	1 1/4	1 1/2	4,5	4	0,15	I
SHF(L)-100-1012-01	10325033201	34,8	40,5	1 1/4	1 1/2	4,5	4	0,15	I
SHF(L)-100-1013	10325035501	34,8	40,5	1 1/4	1 5/8	4,5	4	0,15	I
SHF(L)-100-1013-01	10325038901	34,8	40,5	1 1/4	1 5/8	4,5	4	0,15	I
SHF(L)-140-1113	10325038101	41	58,4	1 3/8	1 5/8	4,5	4	0,15	I
SHF(L)-140-1213	10325038601	41	58,4	1 1/2	1 5/8	4,5	4	0,15	I
SHF(L)-140-1214	10180940401	41	58,4	1 1/2	1 3/4	4,5	4	0,15	I
SHF(L)-140-1313	10325034101	41	58,4	1 5/8	1 5/8	4,5	4	0,15	I
SHF(L)-175-1217	10325030401	46,4	70,5	1 1/2	2 1/8	4,5	4	0,15	I
SHF(L)-175-1317	10325034001	46,4	70,5	1 5/8	2 1/8	4,5	4	0,15	I
SHF(L)-210-1321	10325030501	50	84,4	1 5/8	2 5/8	4,5	4	0,15	I
SHF(L)-350-1721	10325043301	59	138,4	2 1/8	2 5/8	4,5	4	0,15	I
SHF(L)-420-2125	10325043601	69	177	2 5/8	3 1/8	4,5	4	0,15	I



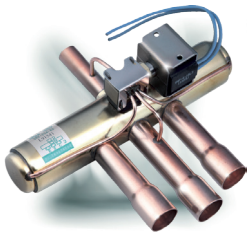

SANHUA SHF SERIE 4-Wege-Umkehrventile

LEISTUNGSDATEN - AUSLEGUNGSTABELLE

Modell	Artikel-nummer	Nennkühlleistung (Betriebspunkt 1)							
		R407C ²⁾		R410A		R134a		R404A / R507	
		$\Delta P:$ 0,1 bar	$\Delta P:$ 0,2 bar	$\Delta P:$ 0,1 bar	$\Delta P:$ 0,2 bar	$\Delta P:$ 0,1 bar	$\Delta P:$ 0,2 bar	$\Delta P:$ 0,1 bar	$\Delta P:$ 0,2 bar
		[kW]	[kW]	[kW]	[kW]	[kW]	[kW]	[kW]	[kW]
SHF(L)-3H-12U-51	10180944702	3,3	4,7	4,0	5,7	2,6	3,7	2,9	4,0
SHF(L)-4H-23U-51	10180944902	3,6	5,0	4,3	6,1	2,8	4,0	3,1	4,3
SHF(L)-7H-34U-51	10180945302	6,5	9,1	7,8	11,0	5,1	7,2	5,5	7,8
SHF(L)-7H-34-51	10180944002	6,5	9,1	7,8	11,0	5,1	7,2	5,5	7,8
SHF(L)-7H-35-51	10180945002	6,5	9,1	7,8	11,0	5,1	7,2	5,5	7,8
SHF(L)-11H-34U-51	10180947302	10,0	14,2	12,1	17,1	7,9	11,1	8,6	12,1
SHF(L)-11H-35U-51	10180942902	10,0	14,2	12,1	17,1	7,9	11,1	8,6	12,1
SHF(L)-11H-45D1-51	10180943002	10,0	14,2	12,1	17,1	7,9	11,1	8,6	12,1
SHF(L)-11H-46D1-51	10180944602	10,0	14,2	12,1	17,1	7,9	11,1	8,6	12,1
SHF-14A-46	10325030102	14,7	20,8	17,7	25,1	11,5	16,3	12,6	17,8
SHF-20D-46-02	10325020102	21,2	29,9	25,5	36,1	16,6	23,5	18,1	25,6
SHF-20D-47-02	10325030302	22,1	31,2	26,6	37,7	17,3	24,5	18,9	26,7
SHF-20D-57-02	10325032902	22,1	31,2	26,6	37,7	17,3	24,5	18,9	26,7
SHF-20D-67-02	10325039802	22,1	31,2	26,6	37,7	17,3	24,5	18,9	26,7
SHF-35B-47-04	10325033602	32,7	46,3	39,5	55,9	25,7	36,3	28,1	39,7
SHF-35B-57-04	10325035702	32,7	46,3	39,5	55,9	25,7	36,3	28,1	39,7
SHF-35B-59-04	10325039902	32,7	46,3	39,5	55,9	25,7	36,3	28,1	39,7
SHF-35B-67-04	10325031002	32,7	46,3	39,5	55,9	25,7	36,3	28,1	39,7
SHF-35B-69-04	10325035802	32,7	46,3	39,5	55,9	25,7	36,3	28,1	39,7
SHF-35B-79-04	10325033002	32,7	46,3	39,5	55,9	25,7	36,3	28,1	39,7
SHF-50A-79	10325030002	40,8	57,7	49,2	69,6	32,0	45,2	34,9	49,4
SHF-50-911D2	10325011602	41,2	58,3	49,8	70,4	32,3	45,7	35,3	49,9
SHF(L)-70-810	10325030201	63,5	89,8	76,6	108,4	49,8	70,4	54,4	76,9
SHF(L)-70-810-01	10325033101	63,5	89,8	76,6	108,4	49,8	70,4	54,4	76,9
SHF(L)-70-911	10325038301	63,5	89,8	76,6	108,4	49,8	70,4	54,4	76,9
SHF(L)-70-911-01	10325038301	63,5	89,8	76,6	108,4	49,8	70,4	54,4	76,9
SHF(L)-70-913-05	10325039501	63,5	89,8	76,6	108,4	49,8	70,4	54,4	76,9
SHF(L)-70-913-03	10325039701	63,5	89,8	76,6	108,4	49,8	70,4	54,4	76,9
SHF(L)-100-911	10325037901	90,2	127,6	108,9	154,0	70,8	100,1	77,3	109,3

DS-SHF-DE-R1702
Copyright © SANHUA 2017 Änderungen ohne Vorankündigung vorbehalten



CHILLING IDEAS WORLDWIDE

SANHUA INTERNATIONAL EUROPE
sanhuaeurope.com

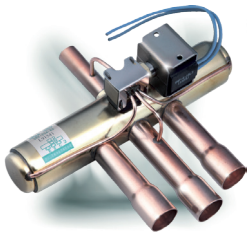

SANHUA SHF SERIE 4-Wege-Umkehrventile

LEISTUNGSDATEN - AUSLEGUNGSTABELLE

Modell	Artikel-nummer	Nennkühlleistung (Betriebspunkt 1)							
		R407C ²⁾		R410A		R134a		R404A / R507	
		$\Delta P:$ 0,1 bar	$\Delta P:$ 0,2 bar	$\Delta P:$ 0,1 bar	$\Delta P:$ 0,2 bar	$\Delta P:$ 0,1 bar	$\Delta P:$ 0,2 bar	$\Delta P:$ 0,1 bar	$\Delta P:$ 0,2 bar
		[kW]	[kW]	[kW]	[kW]	[kW]	[kW]	[kW]	[kW]
SHF(L)-100-911-01	10325038001	90,2	127,6	108,9	154,0	70,8	100,1	77,3	109,3
SHF(L)-100-913	10325033701	90,2	127,6	108,9	154,0	70,8	100,1	77,3	109,3
SHF(L)-100-913-01	10325034701	90,2	127,6	108,9	154,0	70,8	100,1	77,3	109,3
SHF(L)-100-1012	10325027101	90,2	127,6	108,9	154,0	70,8	100,1	77,3	109,3
SHF(L)-100-1012-01	10325033201	90,2	127,6	108,9	154,0	70,8	100,1	77,3	109,3
SHF(L)-100-1013	10325035501	90,2	127,6	108,9	154,0	70,8	100,1	77,3	109,3
SHF(L)-100-1013-01	10325038901	90,2	127,6	108,9	154,0	70,8	100,1	77,3	109,3
SHF(L)-140-1113	10325038101	130,1	184,0	157,1	222,1	102,0	144,3	111,5	157,6
SHF(L)-140-1213	10325038601	130,1	184,0	157,1	222,1	102,0	144,3	111,5	157,6
SHF(L)-140-1214	10180940401	130,1	184,0	157,1	222,1	102,0	144,3	111,5	157,6
SHF(L)-140-1313	10325034101	130,1	184,0	157,1	222,1	102,0	144,3	111,5	157,6
SHF(L)-175-1217	10325030401	157,0	222,1	189,6	268,1	123,2	174,2	134,6	190,3
SHF(L)-175-1317	10325034001	157,0	222,1	189,6	268,1	123,2	174,2	134,6	190,3
SHF(L)-210-1321	10325030501	188,0	265,9	227,0	321,0	147,5	208,6	161,1	227,8
SHF(L)-350-1721	10325043301	308,3	436,0	372,2	526,4	241,8	342,0	264,2	373,6
SHF(L)-420-2125	10325043601	394,3	557,6	476,0	673,2	309,3	437,4	337,8	477,8



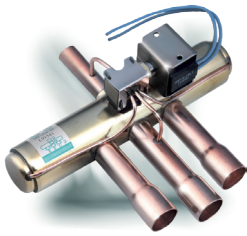

SANHUA SHF SERIE 4-Wege-Umkehrventile

LEISTUNGSDATEN - AUSLEGUNGSTABELLE

Modell	Artikel-nummer	Nennkühlleistung (Betriebspunkt 2)							
		R407C ²⁾		R410A		R134a		R404A / R507	
		$\Delta P:$ 0,1 bar	$\Delta P:$ 0,2 bar	$\Delta P:$ 0,1 bar	$\Delta P:$ 0,2 bar	$\Delta P:$ 0,1 bar	$\Delta P:$ 0,2 bar	$\Delta P:$ 0,1 bar	$\Delta P:$ 0,2 bar
		[kW]	[kW]	[kW]	[kW]	[kW]	[kW]	[kW]	[kW]
SHF(L)-3H-12U-51	10180944702	3,0	4,3	3,6	5,0	2,4	3,4	2,4	3,4
SHF(L)-4H-23U-51	10180944902	3,2	4,6	3,8	5,4	2,6	3,7	2,6	3,7
SHF(L)-7H-34U-51	10180945302	5,9	8,3	6,9	9,7	4,7	6,6	4,7	6,6
SHF(L)-7H-34-51	10180944002	5,9	8,3	6,9	9,7	4,7	6,6	4,7	6,6
SHF(L)-7H-35-51	10180945002	5,9	8,3	6,9	9,7	4,7	6,6	4,7	6,6
SHF(L)-11H-34U-51	10180947302	9,1	12,9	10,7	15,1	7,3	10,3	7,3	10,3
SHF(L)-11H-35U-51	10180942902	9,1	12,9	10,7	15,1	7,3	10,3	7,3	10,3
SHF(L)-11H-45D1-51	10180943002	9,1	12,9	10,7	15,1	7,3	10,3	7,3	10,3
SHF(L)-11H-46D1-51	10180944602	9,1	12,9	10,7	15,1	7,3	10,3	7,3	10,3
SHF-14A-46	10325030102	13,4	18,9	15,7	22,2	10,7	15,1	10,7	15,1
SHF-20D-46-02	10325020102	19,3	27,3	22,5	31,9	15,4	21,7	15,4	21,7
SHF-20D-47-02	10325030302	20,1	28,4	23,5	33,2	16,0	22,7	16,0	22,6
SHF-20D-57-02	10325032902	20,1	28,4	23,5	33,2	16,0	22,7	16,0	22,6
SHF-20D-67-02	10325039802	20,1	28,4	23,5	33,2	16,0	22,7	16,0	22,6
SHF-35B-47-04	10325033602	29,8	42,2	34,9	49,3	23,8	33,7	23,8	33,6
SHF-35B-57-04	10325035702	29,8	42,2	34,9	49,3	23,8	33,7	23,8	33,6
SHF-35B-59-04	10325039902	29,8	42,2	34,9	49,3	23,8	33,7	23,8	33,6
SHF-35B-67-04	10325031002	29,8	42,2	34,9	49,3	23,8	33,7	23,8	33,6
SHF-35B-69-04	10325035802	29,8	42,2	34,9	49,3	23,8	33,7	23,8	33,6
SHF-35B-79-04	10325033002	29,8	42,2	34,9	49,3	23,8	33,7	23,8	33,6
SHF-50A-79	10325030002	37,1	52,5	43,4	61,4	29,6	41,9	29,6	41,8
SHF-50-911D2	10325011602	37,5	53,1	43,9	62,1	29,9	42,4	29,9	42,3
SHF(L)-70-810	10325030201	57,8	81,8	67,6	95,7	46,1	65,2	46,1	65,2
SHF(L)-70-810-01	10325033101	57,8	81,8	67,6	95,7	46,1	65,2	46,1	65,2
SHF(L)-70-911	10325038301	57,8	81,8	67,6	95,7	46,1	65,2	46,1	65,2
SHF(L)-70-911-01	10325038301	57,8	81,8	67,6	95,7	46,1	65,2	46,1	65,2
SHF(L)-70-913-05	10325039501	57,8	81,8	67,6	95,7	46,1	65,2	46,1	65,2
SHF(L)-70-913-03	10325039701	57,8	81,8	67,6	95,7	46,1	65,2	46,1	65,2
SHF(L)-100-911	10325037901	82,2	116,2	96,1	136,0	65,6	92,7	65,5	92,6

DS-SHF-DE-R1702
Copyright © SANHUA 2017 Änderungen ohne Vorankündigung vorbehalten



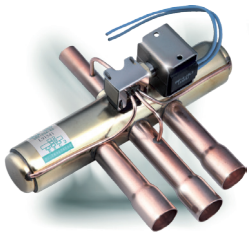

SANHUA SHF SERIE 4-Wege-Umkehrventile

LEISTUNGSDATEN - AUSLEGUNGSTABELLE

Modell	Artikel-nummer	Nennkühlleistung (Betriebspunkt 2)							
		R407C ²⁾		R410A		R134a		R404A / R507	
		$\Delta P:$ 0,1 bar	$\Delta P:$ 0,2 bar	$\Delta P:$ 0,1 bar	$\Delta P:$ 0,2 bar	$\Delta P:$ 0,1 bar	$\Delta P:$ 0,2 bar	$\Delta P:$ 0,1 bar	$\Delta P:$ 0,2 bar
		[kW]	[kW]	[kW]	[kW]	[kW]	[kW]	[kW]	[kW]
SHF(L)-100-911-01	10325038001	82,2	116,2	96,1	136,0	65,6	92,7	65,5	92,6
SHF(L)-100-913	10325033701	82,2	116,2	96,1	136,0	65,6	92,7	65,5	92,6
SHF(L)-100-913-01	10325034701	82,2	116,2	96,1	136,0	65,6	92,7	65,5	92,6
SHF(L)-100-1012	10325027101	82,2	116,2	96,1	136,0	65,6	92,7	65,5	92,6
SHF(L)-100-1012-01	10325033201	82,2	116,2	96,1	136,0	65,6	92,7	65,5	92,6
SHF(L)-100-1013	10325035501	82,2	116,2	96,1	136,0	65,6	92,7	65,5	92,6
SHF(L)-100-1013-01	10325038901	82,2	116,2	96,1	136,0	65,6	92,7	65,5	92,6
SHF(L)-140-1113	10325038101	118,5	167,5	138,6	196,0	94,5	133,7	94,4	133,5
SHF(L)-140-1213	10325038601	118,5	167,5	138,6	196,0	94,5	133,7	94,4	133,5
SHF(L)-140-1214	10180940401	118,5	167,5	138,6	196,0	94,5	133,7	94,4	133,5
SHF(L)-140-1313	10325034101	118,5	167,5	138,6	196,0	94,5	133,7	94,4	133,5
SHF(L)-175-1217	10325030401	143,0	202,2	167,3	236,7	114,1	161,4	114,0	161,2
SHF(L)-175-1317	10325034001	143,0	202,2	167,3	236,7	114,1	161,4	114,0	161,2
SHF(L)-210-1321	10325030501	171,2	242,1	200,3	283,3	136,6	193,2	136,5	193,0
SHF(L)-350-1721	10325043301	280,7	397,0	328,5	464,6	224,1	316,9	223,8	316,4
SHF(L)-420-2125	10325043601	359,0	507,8	420,1	594,2	286,5	405,2	286,2	404,7



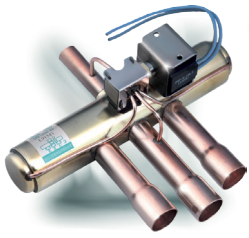

SANHUA SHF SERIE 4-Wege-Umkehrventile

ABMESSUNGEN - VENTILE

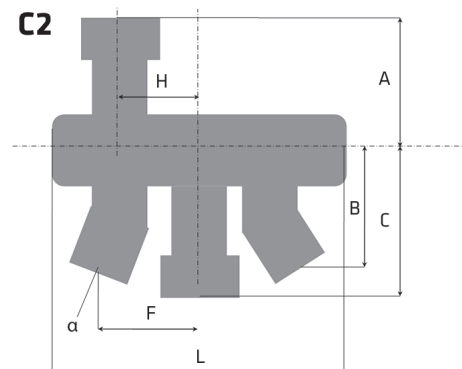
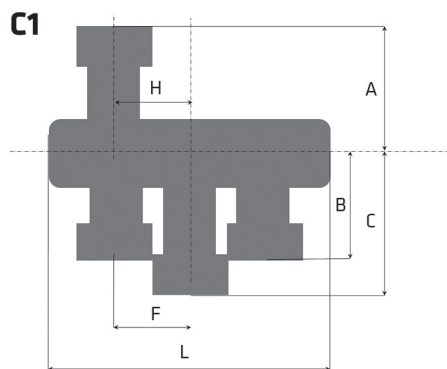
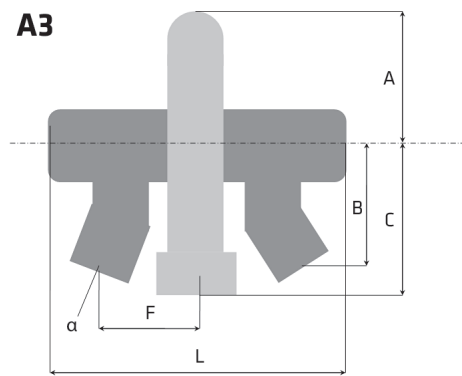
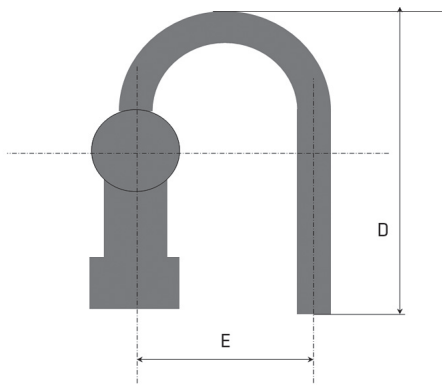
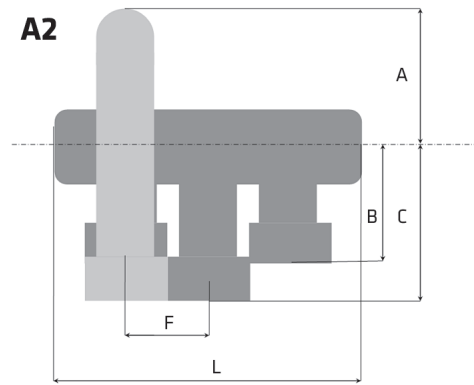
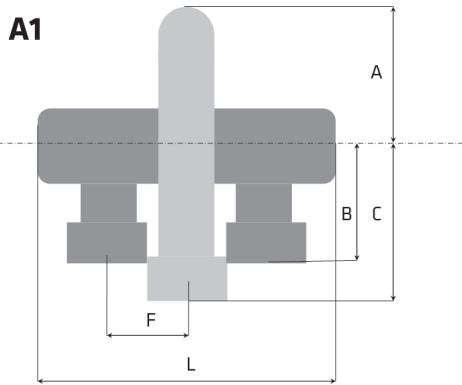

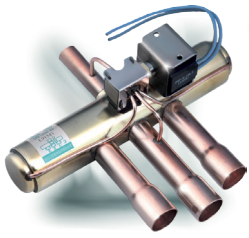

SANHUA SHF SERIE 4-Wege-Umkehrventile

ABMESSUNGEN - VENTILE

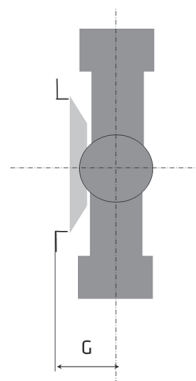
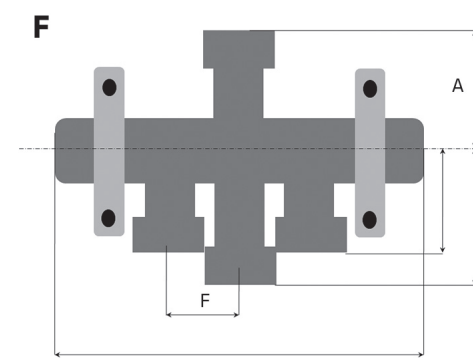
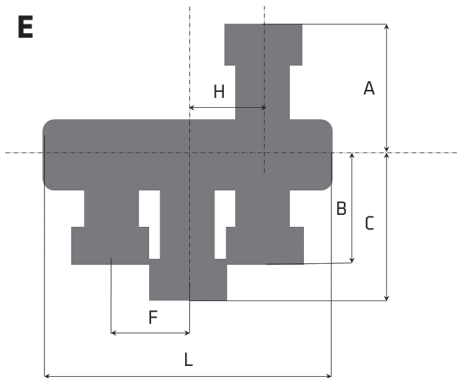
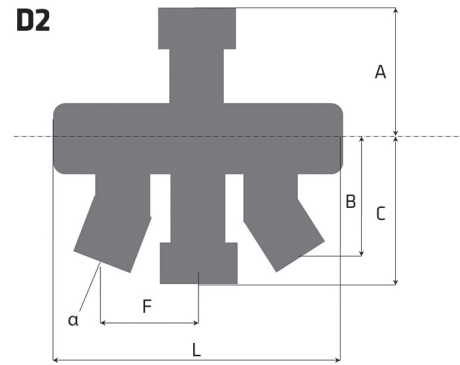
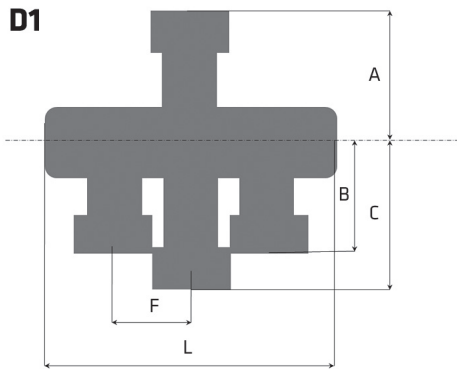

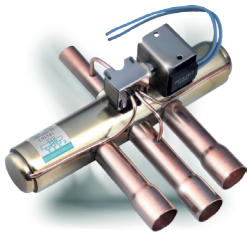

SANHUA SHF SERIE 4-Wege-Umkehrventile

ABMESSUNGEN - VENTILE

Modell	Artikel-nummer	Ventil- typ	L	A	B	C	D	E	F	G	H	Winkel α	Gewicht
			[mm]	[mm]	[mm]	[mm]	[mm]	[mm]	[mm]	[mm]	[mm]	[°]	
SHF(L)-3H-12U-51	10180944702	A1	88,2	38,5	38	50	88,5	43	11	-	-	0	0,2
SHF(L)-4H-23U-51	10180944902	A1	94,4	43	50	62	105	43	12	-	-	0	0,2
SHF(L)-7H-34U-51	10180945302	A1	113	52	59	71	119	52	16	-	-	0	0,3
SHF(L)-7H-34-51	10180944002	D1	113	52	59	71	-	-	16	-	-	0	0,3
SHF(L)-7H-35-51	10180945002	D2	113	52	57	72	-	-	23,5	-	16	0	0,3
SHF(L)-11H-34U-51	10180947302	A1	115,5	51	59	71	119	52	16	-	-	0	0,3
SHF(L)-11H-35U-51	10180942902	A3	115,5	51	57	71	119	52	23,5	-	-	15	0,3
SHF(L)-11H-45D1-51	10180943002	C2	117	52	62	87	-	-	25	-	16	15	0,32
SHF(L)-11H-46D1-51	10180944602	C2	117	52	82	87	-	-	32,5	-	16	20	0,35
SHF-14A-46	10325030102	D1	163	67	83	95	-	-	23,8	-	-	0	0,72
SHF-20D-46-02	10325020102	D1	183,6	67	83	95	-	-	28,6	-	-	0	0,75
SHF-20D-47-02	10325030302	D1	183,6	67	83	95	-	-	28,6	-	-	0	0,75
SHF-20D-57-02	10325032902	D1	183,6	67	83	95	-	-	28,6	-	-	0	0,75
SHF-20D-67-02	10325039802	D1	183,6	67	83	95	-	-	28,6	-	-	0	0,75
SHF-35B-47-04	10325033602	D1	212,2	82	87	100	-	-	33	-	-	0	1,3
SHF-35B-57-04	10325035702	D1	212,2	82	87	100	-	-	33	-	-	0	1,3
SHF-35B-59-04	10325039902	D1	212,2	82	87	100	-	-	33	-	-	0	1,3
SHF-35B-67-04	10325031002	D1	212,2	82	87	100	-	-	33	-	-	0	1,3
SHF-35B-69-04	10325035802	D1	212,2	82	87	100	-	-	33	-	-	0	1,3
SHF-35B-79-04	10325033002	D1	212,2	82	87	100	-	-	33	-	-	0	1,3
SHF-50A-79	10325030002	D1	217	91	96	128	-	-	33	-	-	0	2,1
SHF-50-911D2	10325011602	E	269	97	149	174	-	-	41,3	-	41,3	0	2,1
SHF(L)-70-810	10325030201	D1	303	111	117	131	-	-	46	-	-	0	3
SHF(L)-70-810-01	10325033101	F	303	111	117	154	-	-	46	58	-	0	3
SHF(L)-70-911	10325038301	D1	303	111	117	154	-	-	46	-	-	0	3
SHF(L)-70-911-01	10325038301	F	321	111	117	131	-	-	49	58	-	0	3,5
SHF(L)-70-913-05	10325039501	D1	321	111	117	131	-	-	49	-	-	0	3,5
SHF(L)-70-913-03	10325039701	F	321	111	117	131	-	-	49	58	-	0	3,5
SHF(L)-100-911	10325037901	D1	321	111	117	131	-	-	49	-	-	0	3,5

DS-SHF-DE-R1702
Copyright © SANHUA 2017 Änderungen ohne Vorankündigung vorbehalten



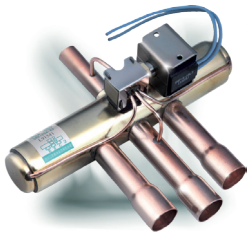

SANHUA SHF SERIE 4-Wege-Umkehrventile

ABMESSUNGEN - VENTILE

Modell	Artikel-nummer	Ventil- typ	L	A	B	C	D	E	F	G	H	Winkel α	Gewicht
			[mm]	[mm]	[mm]	[mm]	[mm]	[mm]	[mm]	[mm]	[mm]	[mm]	[°]
SHF(L)-100-911-01	10325038001	F	303	111	117	131	-	-	46	58	-	0	3
SHF(L)-100-913	10325033701	D1	303	111	117	154	-	-	46	-	-	0	3
SHF(L)-100-913-01	10325034701	F	303	111	117	154	-	-	46	58	-	0	3
SHF(L)-100-1012	10325027101	D1	321	111	117	131	-	-	49	-	-	0	3,5
SHF(L)-100-1012-01	10325033201	F	321	111	117	131	-	-	49	58	-	0	3,5
SHF(L)-100-1013	10325035501	D1	321	111	117	131	-	-	49	-	-	0	3,5
SHF(L)-100-1013-01	10325038901	F	321	111	117	131	-	-	49	58	-	0	3,5
SHF(L)-140-1113	10325038101	F	390	135,6	148,7	168,7	-	-	58	63	-	0	7,2
SHF(L)-140-1213	10325038601	F	390	135,6	148,7	168,7	-	-	58	63	-	0	7,2
SHF(L)-140-1214	10180940401	F	390	135,6	148,7	168,7	-	-	58	63	-	0	7,2
SHF(L)-140-1313	10325034101	F	390	135,6	148,7	168,7	-	-	58	63	-	0	7,2
SHF(L)-175-1217	10325030401	F	390	135,6	148,7	198	-	-	58	63	-	0	7,6
SHF(L)-175-1317	10325034001	F	390	135,6	148,7	198	-	-	58	63	-	0	7,6
SHF(L)-210-1321	10325030501	F	452	135,6	148,7	198	-	-	71,5	63	-	0	8,7
SHF(L)-350-1721	10325043301	F	531	176,5	184	240	-	-	75	82,5	-	0	22
SHF(L)-420-2125	10325043601	F	611,7	176,5	184	240	-	-	93	82,5	-	0	26



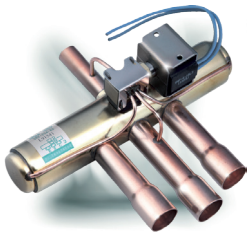

SANHUA SHF SERIE 4-Wege-Umkehrventile

PARAMETER DER SPULE

Spule Modell ¹⁾	Wicklung	Artikelnummer	Elektrischer Anschlusstyp	Kabellänge	Netz	Nennspannung	Leistungsaufnahme			Schutzklasse	Isolationsklasse	Max. Betriebstemp.
							AC 50Hz	AC 60Hz	DC			
							[W]	[W]	[W]			
				[mm]	[-]	[V]				[-]	[-]	[°C]
SQ-A25 22G-00 0001	SHF-4-10L3	10805029102	Kabel	500	AC	220-240	4,5	3,5	-	IP54	B ²⁾	130
SQ-A25 200-00 0001	SHF-4-10L2	10805027002	Kabel	500	AC	200	4,5	3,5	-			
SQ-A25 100-00 0001	SHF-4-10L1	10805023602	Kabel	500	AC	100	4,5	3,5	-			
SQ-A25 11A-00 0001	SHF-4-10L4	10805150302	Kabel	500	AC	110-120	4,5	3,5	-			
SQ-A25 024-00 0001	SHF-4-10L5	10805227602	Kabel	500	AC	24	4,5	3,5	-			
SQ-A25 26H-00 0001	SHF-4-10L6	10805231902	Kabel	500	AC	265-277	4,5	3,5	-			
SQ-A25 22G-00 0870	SHF-4-10L3	10805240702	Kabel	1500	AC	220-240	4,5	3,5	-	IP00	F ²⁾	155
SQ-A25 11A-00 0840	SHF-4-10L4	10805240802	Kabel	1500	AC	110-120	4,5	3,5	-			
SQ-A25 024-00 0161	SHF-4-10L5	10805023002	Kabel	1500	AC	24	4,5	3,5	-			
SQ-A47 22G-00 0001	SHF-4-10FA5	10805263402	Flachstecker (Faston) ³⁾	-	AC	220-240	6	5	-			
SQ-A47 220-00 0001	SHF-4-10FA1	10805273402	Flachstecker (Faston) ³⁾	-	AC	220	6	5	-			
SQ-A47 11B-00 0001	SHF-4-10FA2	10805273302	Flachstecker (Faston) ³⁾	-	AC	120	6	5	-			
SQ-A47 10A-00 0001	SHF-4-10FA3	10805268702	Flachstecker (Faston) ³⁾	-	AC	100-110	6	5	-	IP54	B ²⁾	130
SQ-A47 024-00 0001	SHF-4-10FA4	10805263302	Flachstecker (Faston) ³⁾	-	AC	24	6	5	-			
SQ-A47 26H-00 0001	SHF-4-10FA6	10805273502	Flachstecker (Faston) ³⁾	-	AC	265-277	6	5	-			
SQ-D44 012-00 0001	SHF-4-10FA8	10805231802	Flachstecker (Faston) ³⁾	-	DC	12	-	-	10			
SQ-D44 024-00 0001	SHF-4-10FA9	10805070102	Flachstecker (Faston) ³⁾	-	DC	24	-	-	11			
SQ-A27 100-00 0001	-	10805063202	Bistabil/Kabel	500	AC	100	18	18	-			
SQ-A27 200-00 0001	-	10805063802	Bistabil/Kabel	500	AC	200	18	18	-			
SQ-A27 20K-00 0001	-	10805222902	Bistabil/Kabel	500	AC	220-240	18	18	-			
SQ-D27 012-00 0001	-	10805069302	Bistabil/Kabel	500	DC	12	-	-	20			

Hinweis:

- 1) Alle Spulen sind mit allen in diesem Dokument gelisteten Ventilen einsetzbar
- 2) Die maximale Umgebungstemperatur beträgt + 50 °C
- 3) Kabelsatz für Spule mit Flachsteckeranschlüssen ist als Zubehör erhältlich



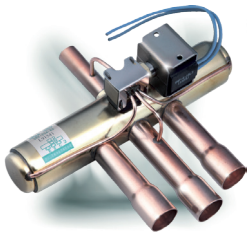

SANHUA SHF SERIE 4-Wege-Umkehrventile

ZUBEHÖR

Kabelsatz		
Modell	Artikelnummer	Kabellänge [mm]
SQ-000000-090028	20805136301	1200
SQ-000000-090029	20805149201	2000

ABMESSUNGEN - SPULEN

Spulen mit Kabel (SQ-A25 Serie)

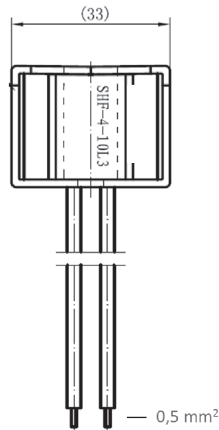
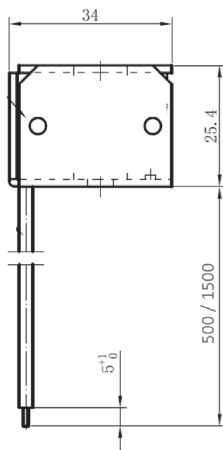

Bistabile Spulen (SQ-A27/D27 Series)

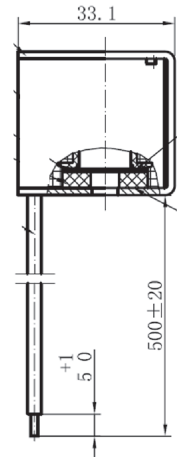
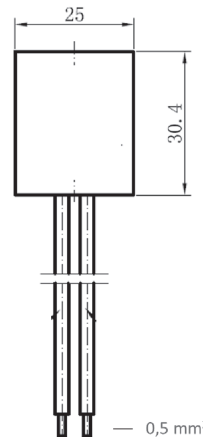

Spulen mit Flachsteckeranschlüssen (SQ-A47 and SQ-D44 Series)

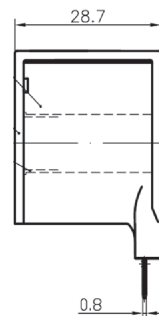
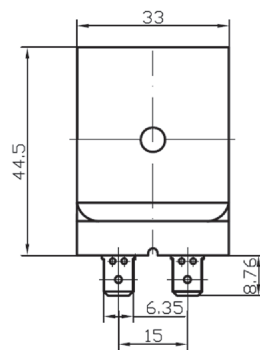

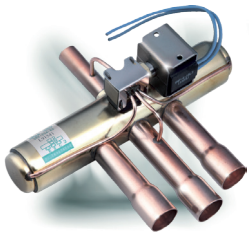

SANHUA SHF SERIE 4-Wege-Umkehrventile

Kabelsatz für Spulen mit Flachstecker
(SQ-000000-0900xx)

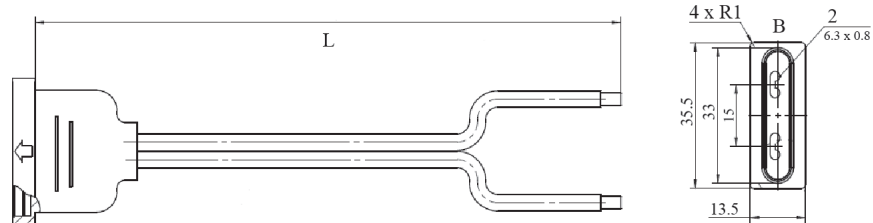

ANHANG 1

Alte- und neue Artikelnummern / Übersetzung

Modell	Artikelnummer ALT	Artikelnummer NEU
SHF(L)-3H-12U-51	SHF-19007	10180944702
SHF(L)-4H-23U-51	SHF-19008	10180944902
SHF(L)-7H-34U-51	SHF-19020	10180945302
SHF(L)-7H-34-51	SHF-19021	10180944002
SHF(L)-7H-35-51	SHF-19011	10180945002
SHF(L)-11H-34U-51	SHF-19022	10180947302
SHF(L)-11H-35U-51	SHF-19013	10180942902
SHF(L)-11H-45D1-51	SHF-19014	10180943002
SHF(L)-11H-46D1-51	SHF-19015	10180944602
SHF-14A-46	SHF-50033	10325030102
SHF-20D-46-02	SHF-50022	10325020102
SHF-20D-47-02	SHF-50041	10325030302
SHF-20D-57-02	SHF-50042	10325032902
SHF-20D-67-02	SHF-50043	10325039802
SHF-35B-47-04	SHF-50044	10325033602
SHF-35B-57-04	SHF-50045	10325035702
SHF-35B-59-04	SHF-50046	10325039902
SHF-35B-67-04	SHF-50027	10325031002
SHF-35B-69-04	SHF-50047	10325035802
SHF-35B-79-04	SHF-50048	10325033002



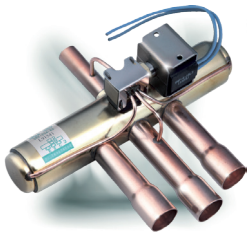

SANHUA SHF SERIE 4-Wege-Umkehrventile

ANHANG 1

Alte- und neue Artikelnummern / Übersetzung

Modell	Artikelnummer ALT	Artikelnummer NEU
SHF-50A-79	SHF-50038	10325030002
SHF-50-911D2	SHF-50016	10325011602
SHF(L)-70-810	SHF-50017	10325030201
SHF(L)-70-810-01	SHF-50024	10325033101
SHF(L)-70-911	SHF-50049	10325038301
SHF(L)-70-911-01	SHF-50050	10325038301
SHF(L)-70-913-05	SHF-50052	10325039501
SHF(L)-70-913-03	SHF-50051	10325039701
SHF(L)-100-911	SHF-50053	10325037901
SHF(L)-100-911-01	SHF-50054	10325038001
SHF(L)-100-913	SHF-50055	10325033701
SHF(L)-100-913-01	SHF-50056	10325034701
SHF(L)-100-1012	SHF-50018	10325027101
SHF(L)-100-1012-01	SHF-50025	10325033201
SHF(L)-100-1013	SHF-50057	10325035501
SHF(L)-100-1013-01	SHF-50058	10325038901
SHF(L)-140-1113	SHF-50059	10325038101
SHF(L)-140-1213	SHF-50060	10325038601
SHF(L)-140-1214	SHF-50019	10180940401
SHF(L)-140-1313	SHF-50061	10325034101
SHF(L)-175-1217	SHF-50020	10325030401
SHF(L)-175-1317	SHF-50062	10325034001
SHF(L)-210-1321	SHF-50021	10325030501
SHF(L)-350-1721	SHF-50031	10325043301
SHF(L)-420-2125	SHF-50032	10325043601

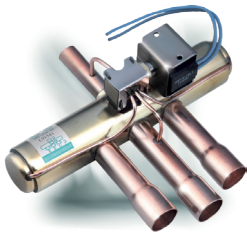

SANHUA SHF SERIE 4-Wege-Umkehrventile

ANHANG 1

Alte- und neue Artikelnummern / Übersetzung

Spule Modell	Artikelnummer ALT	Artikelnummer NEU
SQ-A25 22G-00 0001	SHF-56001	10805029102
SQ-A25 200-00 0001	SHF-56002	10805027002
SQ-A25 100-00 0001	SHF-56003	10805023602
SQ-A25 11A-00 0001	SHF-56004	10805150302
SQ-A25 024-00 0001	SHF-56005	10805227602
SQ-A25 26H-00 0001	SHF-56006	10805231902
SQ-A25 22G-00 0870	SHF-56024	10805240702
SQ-A25 11A-00 0840	SHF-56025	10805240802
SQ-A25 024-00 0161	SHF-56009	10805023002
SQ-A47 22G-00 0001	SHF-56028	10805263402
SQ-A47 220-00 0001	SHF-56029	10805273402
SQ-A47 11B-00 0001	SHF-56030	10805273302
SQ-A47 10A-00 0001	SHF-56031	10805268702
SQ-A47 024-00 0001	SHF-56032	10805263302
SQ-A47 26H-00 0001	SHF-56033	10805273502
SQ-D44 012-00 0001	SHF-56019	10805231802
SQ-D44 024-00 0001	SHF-56020	10805070102
SQ-A27 100-00 0001	SHF-56021	10805063202
SQ-A27 200-00 0001	SHF-56022	10805063802
SQ-A27 20K-00 0001	SHF-56027	10805222902
SQ-D27 012-00 0001	SHF-56023	10805069302

Zubehör	Artikelnummer ALT	Artikelnummer NEU
SQ-000000-090028	SHF-56026	20805136301
SQ-000000-090029	SHF-56034	20805149201

